

MT0303-BL

Features

High Intensity
 Reliable Rugged
 Low Current Requirements
 IC Compatible

Maximum Ratings (Ta=25°C)

Characteristic	Symbol	Max.	Unit
Forward Current	I _F	20	mA
Reverse Voltage	V _R	5	V
Power Dissipation	P _D	80.00	mW
Operating Temperature	T _{opr}	-25 ~ +85	°C
Storage Temperature	T _{stg}	-40 ~ +100	°C
Soldering Temperature	T _{sol}	260	°C
Soldering Time	-	for 5 sec. max	-

Opto-Electrical Characteristics (Ta=25°C)

Characteristic	Symbol	Test Condition	Min	Typ	Max	Unit
Forward Voltage	V _F	I _F =20mA	-	3.20	4.00	V
Reverse Current	I _R	V _R =5V	-	-	50	μA
Luminous Intensity	I _v	I _F =20mA	650.00	1100.00	-	mcd
Viewing Angle	2θ ^{1/2}	-	-	28°	-	deg.
Peak Wavelength	λ _p	I _F =20mA	-	468	-	nm
Dominant Wavelength	λ _d	I _F =20mA	-	470	-	nm
Spectral Line Half Width	Δλ	I _F =20mA	-	26	-	nm

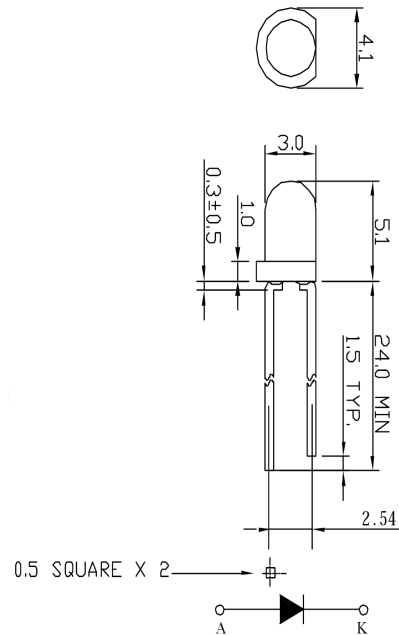

Notes:

1. All dimensions are in millimeters.
2. Tolerance is ±0.25mm unless otherwise noted.

MT0303-BL Graphs

Typical Electrical / Optical Characteristics Curves :

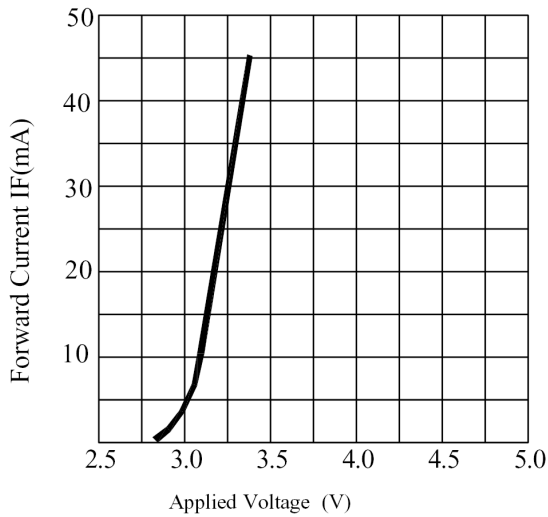

FORWARD CURRENT VS. APPLIED VOLTAGE

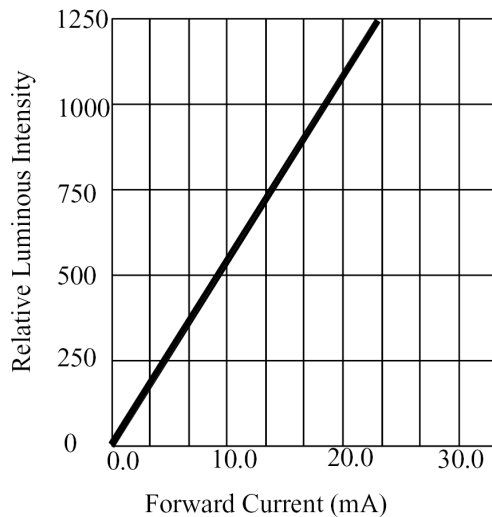

FORWARD CURRENT VS. LUMINOUS INTENSITY

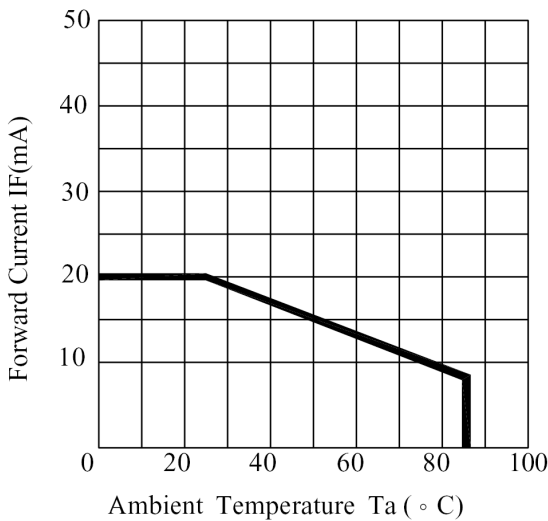

AMBIENT TEMPERATURE VS. FORWARD CURRENT

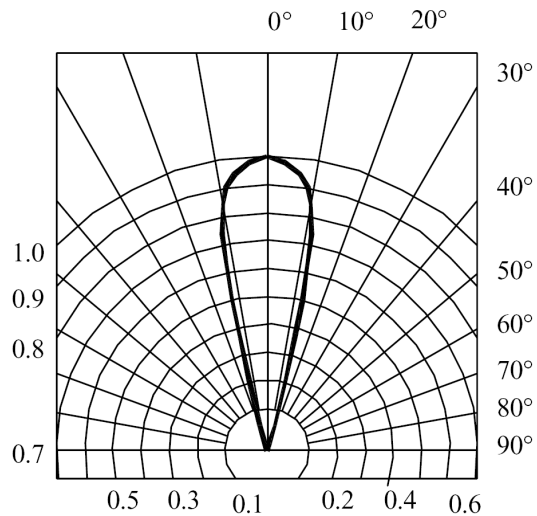

RADIATION DIAGRAM